

10/25/01

S-Series Specifications

Part 1 – General

1.1 Related Documents

- A. Drawings and general provisions contract, including general and supplementary conditions and Division 1 Specifications Section, apply to this section.

1.2 Summary

- A. This section includes the following: *(choose one)*

- 1. Gravity held panels, fully welded hollow steel complete with bolted stringer understructure system as specified in this section.

- 2. Gravity held panels, fully welded hollow steel complete with a stringerless understructure system as specified in this section.

- 3. Cornerbolt panels, fully welded hollow steel complete with understructure system as specified in this section.

(insert any other special items)

- B. Related Sections: The following sections contain requirements that relate to this section:

- 1. Division 3 Section “Concrete Work” for concrete floor sealer.

- 2. Division 16 Section “Grounding” for connection to ground of access floor understructure.

- 3. Division 9 Section “Carpet Tile” for carpet tiles applied over access floor panels.

(insert any other related sections)

1.3 Definitions

- A. Access flooring is a complete portable assembly of modular floor panels on an elevated support system (understructure), forming an accessible underfloor cavity to accommodate electrical and mechanical services.

1.4 System Performance Requirements

- A. Performance requirements, General: Design, engineer, fabricate, and install access flooring to comply with performance requirements specified, as demonstrated by testing of manufacturers corresponding stock systems per test methods specified or, if not specified, manufacturers standard method.

- B. Structural performance per CISCA/AF: Provide access flooring capable of supporting the following loads, within limits and under conditions indicated, as demonstrated by testing according to applicable procedure in Ceilings & Interior Systems Construction Association (CISCA) “Recommended Test Procedures for Access Floors” referenced elsewhere in this section as CISCA/AF.

- 1. Floor panels, including those with cutouts, capable of supporting concentrated design loads of the following magnitude, with a bottom surface beam deflection under load and a permanent set not to exceed respectively, 1/300 of panel span and 0.010”.

(choose one)

- a) 1000 lbs (Model S100)
 - b) 1250 lbs (Model S125)
 - c) 1500 lbs (Model S150)

- 2. Pedestal assemblies capable of withstanding the following types of loads per pedestal, without panels or other supports in place.

- a) Overturning moment of 1000 inch pounds
 - b) Axial load of 5000 lbs.

- 3. Floor system capable of supporting the following loads:

a) Ultimate concentrated load without failure. Ultimate concentrated load shall be not less than value obtained from multiplying the factor indicated below by the specified concentrated design load on floor panels. Failure is defined as the point at which access flooring system will not take any additional load.

Factor 3.0

b) Rolling loads as noted below applied to panels through CISCA/AF wheel 1 with combination of local and overall deformation not to exceed 0.04" measured across panels 24" span and a permanent beam set not to exceed 0.02" after exposure to rolling load over CISCA/AF path A or B, whichever path produced the greatest top surface deformation.

(choose one)

400 lbs (Model S100)

500 lbs (Model S125)

600 lbs (Model S150)

c) Impact load: A load as noted below shall be dropped 36" onto a 1" square indenter. There shall be no system failure.

(choose one)

150 lbs (Model S100)

150 lbs (Model S125)

150 lbs (Model S150)

d) Earthquake loads: Provide access flooring systems capable of withstanding stresses produced by lateral forces of magnitude indicated in geographic zone of installation.

e) Electrical resistance of system: Provide access flooring system with the following electrical resistance characteristics:

1) 10 Ohms or less measured across surface of bare panel to understructure by test method as specified in Chapter 3 of NFPA 99.

1.5 Submittals

- A. General: Submit the following in accordance with Conditions of Contract and Division 1 Specifications section.
- B. Product data for each type of access flooring specified.
- C. Shop drawings indicating complete layout of access flooring based of field verified dimensions; include dimensional relationships to adjoining work installation tolerances. Include details, with descriptive notes indicating materials, finishes, fasteners, typical and special edge conditions, accessories, understructure, and other data to permit a full evaluation of entire access flooring system.
- D. Samples for initial selection purposes in form of manufacturers color charts consisting of actual units or sections of units showing full range of colors, textures, and patterns available for each type of floor covering and exposed finish indicated.
- E. Samples for verification purposes in full size units of each type of floor covering and exposed finish indicated.

1.6 Quality Assurance

- A. Installer qualifications: Engage an experienced installer who is approved by the access flooring manufacturer for installation of the types of access flooring required for this project.
- B. Single Source Responsibility: Obtain access flooring from a single manufacturer.
- C. Coordination of Work: Coordinate location of mechanical and electrical work in underfloor cavity to prevent interferences with access flooring pedestals.

1.7 Delivery, Storage and Handling

- A. Deliver access flooring components in original, unopened packages, clearly labeled with manufacturer's name and item description.
- B. Handle and store packages containing access flooring in a manner which avoids overloading building structure.

1.8 Project Conditions

- A. Environmental conditions: Do not proceed with installation of access flooring until installation area is enclosed and has an ambient temperature of between 55 degrees Fahrenheit and 90 degrees Fahrenheit and a relative humidity of not more than 70 percent.

1.9 Sequencing and Scheduling

- A. Mark pedestal locations by use of a 10'x 10' grid on concrete subfloor so that mechanical and electrical work can take place without interfering with pedestals.
- B. Do not proceed with installation of access flooring until after substantial completion of other performable construction within affected spaces.

1.10 Extra Materials

- A. Deliver extra materials to owner. Furnish 2% extra materials described below matching products installed, packaged with protective covering for storage and identified with labels clearly describing contents.
 - 1. Standard field panels and understructure.

Part 2 – Products

2.1 Manufacturers

- A. Subject to compliance with requirements, provide access flooring by the following, any others must receive prior written approval at least 14 days before bid deadline:

ASM Modular Systems, Inc.
Phone: (843)534-1110

Your local ASM representative:
Advanced Contracting Enterprises, Inc.
740 Double J Road
Covington, LA 70433
(985)898-6311 Fax (985)898-0311

2.2 Floor Panels

- A. General: Provide manufacturer's standard modular field panels of size and construction indicated, that are interchangeable with other standard field panels, easily located and removed without disturbing adjacent panels or understructure by one person using a portable lifting device, free of expose metal edges in installed position with floor covering in place.
- B. Nominal Panel Size: 24"x 24" or 600mm x 600mm
- C. Fabrication Tolerances: Fabricate panels to the following tolerances with squareness tolerances expressed as the difference between diagonal measurements from corner to corner.
 - 1. Size and squareness: Plus or minus 0.015" of required size, with a squareness tolerance of plus or minus 0.020", unless tolerance are otherwise indicated for a specific panel type.
- D. Fully welded die formed hollow steel panels: Fabricate panels with a die formed all steel bottom pan consisting of minimum 64 embossments bottom section, welded to a die cut full hard steel top sheet to form a structural

unitized construction. Panels to be cleaned with a 3 part wash and rinse system, prior to applying a conductive powder coat protective, finish.

2.3 Floor Panel Covering

- A. General: Cover tops of floor panels to comply with requirements indicated for color, pattern, and material. All surface coverings to be factory applied by the manufacturer of the access floor panels.
- B. Colors and Patterns: Provide floor covering materials in colors and patterns as indicated below:
1. Provide selections made by Architect from manufacturers full range of standard colors and patterns.
- C. *(choose from the following)*
1. Plastic Laminate: Provide for panels, High wear type, of grade indicated below; fabricated in one piece to cover each panel face.

choose 1/16" or 1/8" thick
 2. Panels to be provided bare, with standard factory paint finish only.
- D. Edge Condition *(choose from the following)*
1. Manufacturers standard static dissipative edge trim structurally adhered to the perimeter of each panel. (For panels with finished surface only.)
 2. Panel finish is bare; panel surface covering edge treatment is not applicable.
- ### 2.4 Understructure
- A. Pedestals: Provide manufacturers standard pedestal assembly including base, column with provisions for height adjustments, and head (cap), made either of steel or aluminum or a combination of both.

1. Base: Square base plate with not less than 16 square inches of bearing area, embossed for strength.

2. Provide vibration proof mechanism for making and holding fine adjustments in height for leveling purposes over a range of not less than 2". Include means of locking leveling mechanism at a selected height, which requires deliberate action to change height setting and prevents vibratory displacement.

3. Construct pedestal adjusting rod of minimum 3/4" solid steel, and vertical column of 7/8" square steel tubing minimum. All steel components to have manufacturers rust prohibitive finish and precision resistance welded.

4. Fabricate units of sufficient height to provide required underfloor clearance.

(as noted below is stringer system required)

5. Pedestal head to accept bolted stringers as specified below.

B. Stringer system: Manufacturer's modular steel stringer system, designed and fabricated to interlock with pedestal head and to form a grid pattern with members under each edge of each floor panel and with a pedestal under each corner of each floor panel. Protect steel components against corrosion with manufacturer's standard rust prohibitive finish.

1. Provide stringers which support each edge of each full panel where required to meet design load criteria.

2. Heavy duty bolted grid: System of *(choose from the following)* 2'1/2', 4'1/4', 4'1/2' roll formed steel stringers bolted to pedestal heads with 1/4-20 fasteners from top of stringer. Grid shall be capable of supporting a 550 lb. point load at stringers center span, with a permanent set not to average more than 0.010".

C. *(choose from the following)*

1. Panels shall be gravity held on understructure system. Specified.
2. Bare panels shall be corner bolted to stringerless understructure system with one fastener per full panel corner.

2.5 Accessories

- A. Colors and Finishes: For exposed accessories available in more than one standard color or finish, provide color or finish complying with the following requirements:
1. Provide selections made by architect from manufacturers full range of standard colors and finishes for products and materials indicated.
- B. Cutouts: Fabricate cutouts in floor panels to accommodate cable penetrations and service outlets. Comply with requirements indicated for size, shape, number and location. Provide reinforcement or additional support, if needed, to make panels with cutouts comply with standard performance requirements.
1. Fit cutouts with manufacturer's standard grommets in size indicated or, where size of cutouts exceeds maximum grommet size available, trim edge of cutouts with manufacturer's standard plastic molding having tapered top flange. Furnish removable covers for grommets.
 2. Provide foam rubber pads for sealing annular space formed in cutouts by cables and trim edge of cutout with molding having flange and ledge for capturing and supporting pads.
- C. Vertical Closures (Fascia): Where underfloor cavity is not enclosed by abutting walls, columns, beams, or downward slabs, provide manufacturer's standard metal closure plates with factory applied finish.
- D. Ramps: Manufacturer's standard ramp construction of width and slope indicated, but not steeper than 1 in 12, with non slip

raised disc rubber or vinyl floor covering, and of same materials, performance, and construction requirements as the access flooring.

- E. Steps: Provide steps of size and arrangement indicated with floor covering to match access flooring. Apply non slip aluminum nosing to treads unless otherwise indicated.
- F. Panel Lifting Device: Manufacturer's standard portable lifting device of type and number required for lifting panels with floor covering provided.
- G. Perforated Panels: Provide perforated panels with or without *(choose one)* operable dampers and 25% free open area in quantities noted below. Finish to be that as specified for solid floor panels.
1. Provide the following quantity: *(enter quantity)*

Part 3 Execution

3.1 Installation

- A. Install access floor system and accessories under supervision of the access flooring manufacturers authorized representative to ensure rigid, firm installation free of vibration, rocking, rattle, squeaks, and other unacceptable performance.
- B. Set pedestals in adhesive as recommended by the access flooring manufacturer to provide full bearing of the pedestal base on the subfloor.
- C. Layout floor panel installation to keep the number of cut panels at the floor perimeter to a minimum. Scribe panel assemblies at perimeter to provide a close fit with no voids greater than 1/8" where panels abut vertical surfaces.
- D. Secure grid members to pedestal heads in accordance with access floor manufacturers instructions.
- E. Thoroughly clean up dust, dirt and construction debris caused by floor

installation, including vacuuming the subfloor area, as installation of floor panel proceeds. Extend cleaning under installed panels as far as possible.

- F. Level installed access floor to within 0.060" of true level over the entire area and within 0.10" in any 10' distance.
- G. General contractor and/or owner shall suitably protect the completed access floor from damage.

All specifications are subject to change without notice or obligation

S-Series Performance Guide As per CISCA's test procedures

Panel	Applications	Ultimate Load LBS. (KN)	Concentrated Load LBS. (KN)	Deflection* inches/mm	Impact Load LBS. (KN)	Rolling Load 10 Pass LBS. (KN)	Rolling Load 10,000 Pass LBS. (KN)
S100	Standard Duty	3200 (14.08KN)	1000 (4.41KN)	1/300	150 (67KN)	400 (1.77KN)	400 (1.77KN)
S125	Medium Duty	4500 (19.81KN)	1250 (5.51KN)	1/300	150 (67KN)	500 (2.21KN)	500 (2.21KN)
S150	Heavy Duty	5000 (22.01KN)	1500 (6.61KN)	1/300	150 (67KN)	600 (2.65KN)	600 (2.65KN)

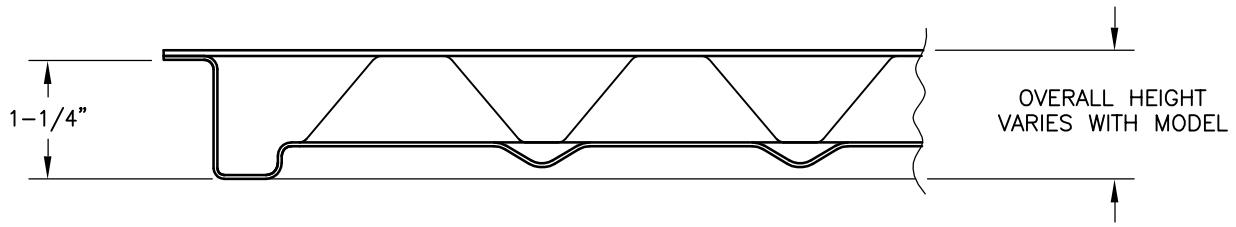

PARTIAL SECTION VIEW

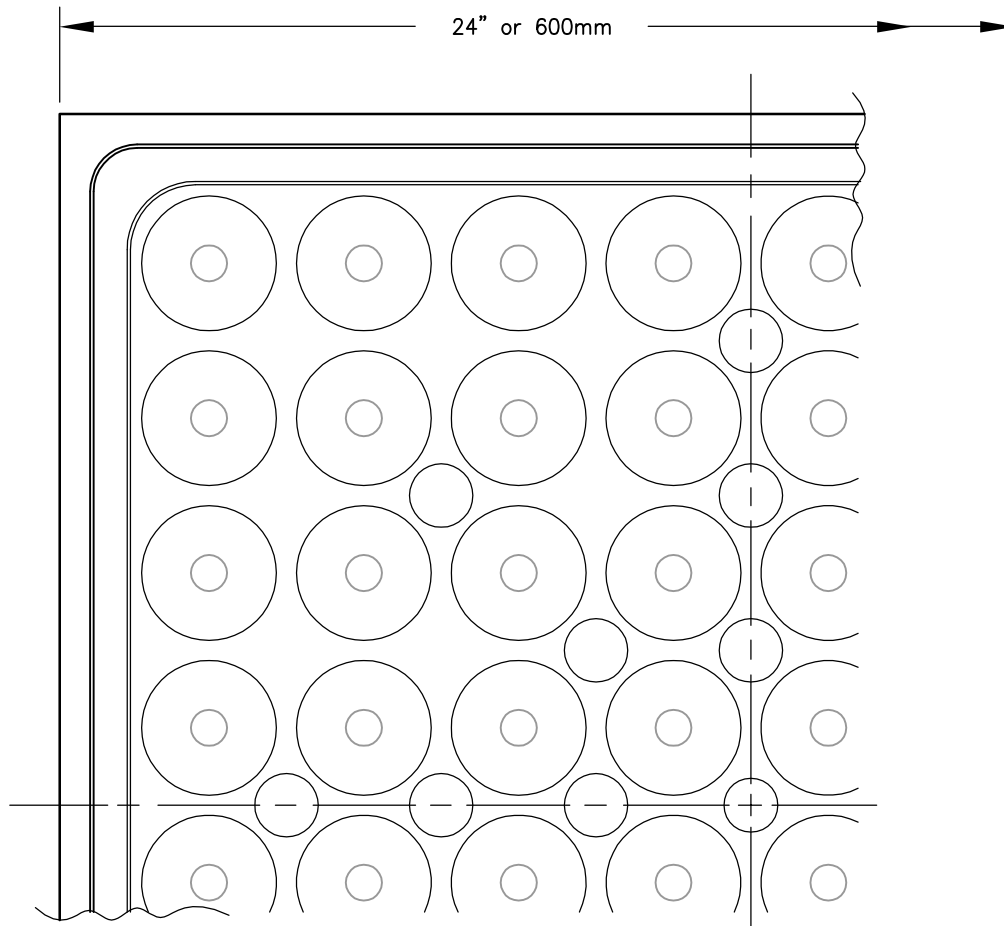

PARTIAL BOTTOM VIEW

SUPPLEMENTARY NOTES

1. PANEL IS PROTECTED WITH POWDER COAT EPOXY

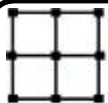

ASM

Constructing a smarter building

USA 843.534.1110
CAN 905.819.5000

www.asmmodularfloors.com
customerservice@asmmodularfloors.com

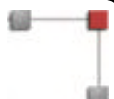

PART NAME:

**S-SERIES HOLLOW
STEEL BARE PANEL
STANDARD OR METRIC**

PART NO:

SCALE:

NTS

DWG:

ASM_1001.dwg

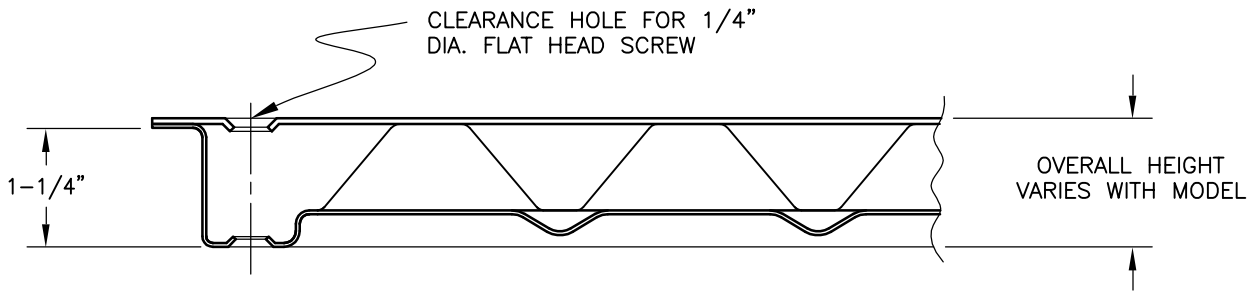

PARTIAL SECTION VIEW

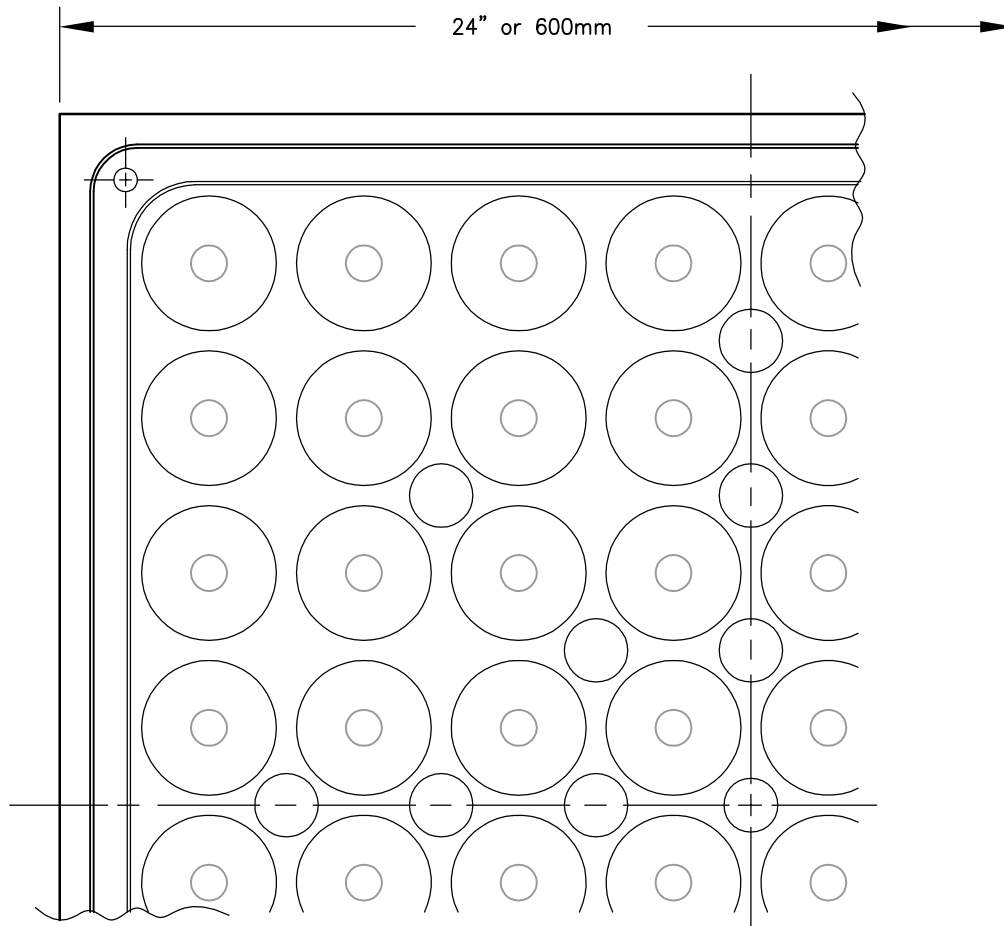

PARTIAL BOTTOM VIEW

SUPPLEMENTARY NOTES

1. PANEL IS PROTECTED WITH POWDER COAT EPOXY

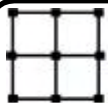

ASM

Constructing a smarter building

USA 843.534.1110
CAN 905.819.5000

www.asmmodularfloors.com
customerservice@asmmodularfloors.com



PART NAME:

**S-SERIES HOLLOW STEEL
CORNERBOLT PANEL
STANDARD OR METRIC**

PART NO:

SCALE:

NTS

DWG:

ASM_1003.dwg

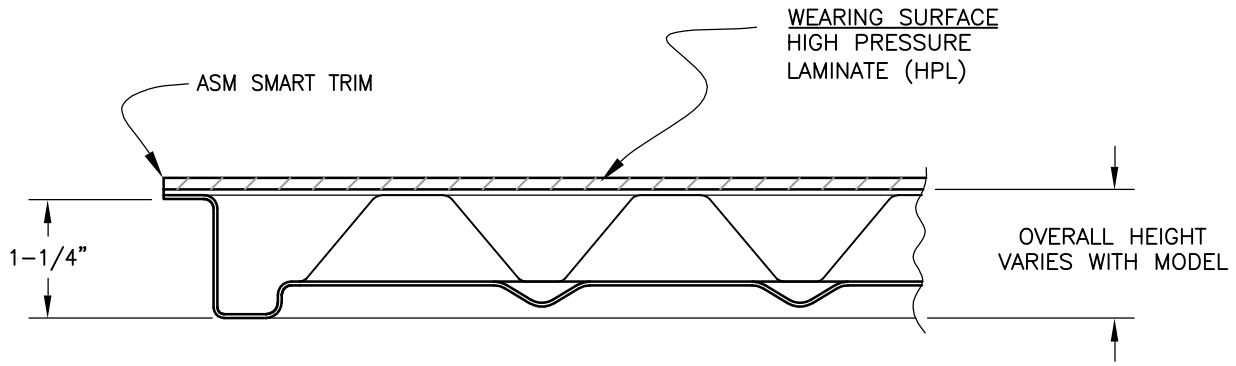

PARTIAL SECTION VIEW

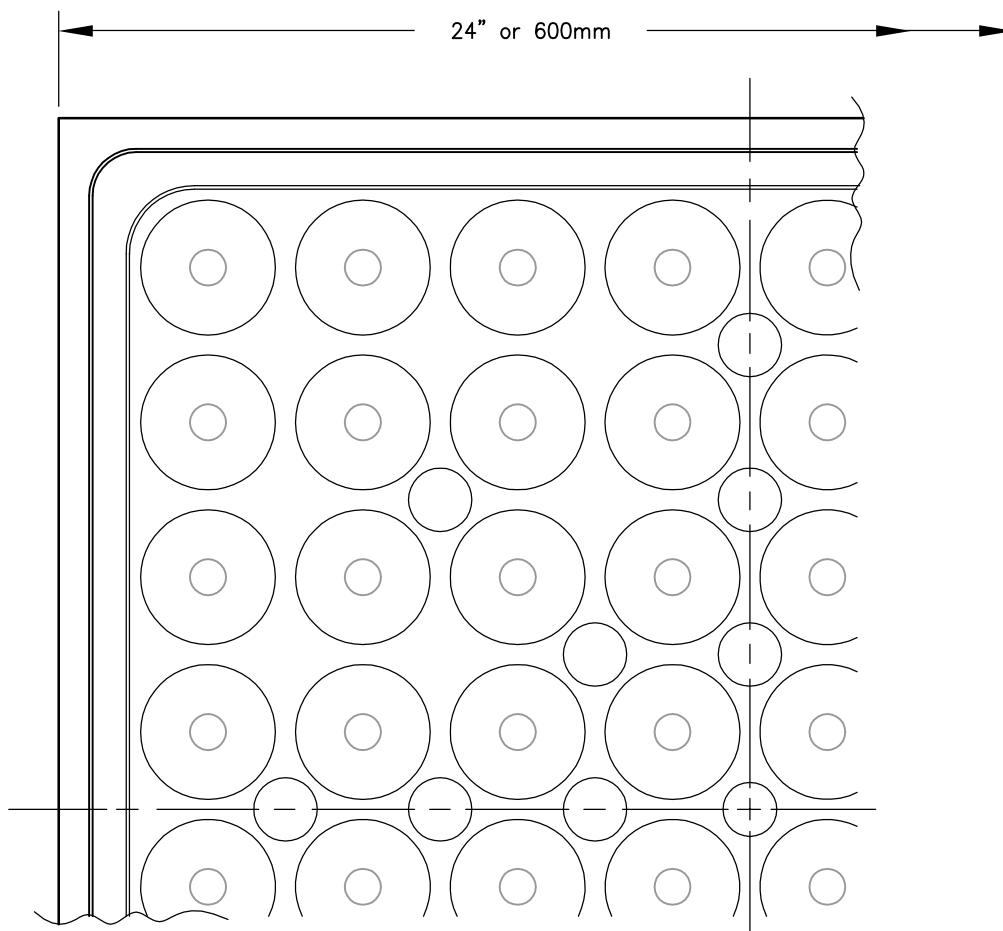

PARTIAL BOTTOM VIEW

SUPPLEMENTARY NOTES

1. PANEL IS PROTECTED WITH POWDER COAT EPOXY

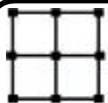

ASM

Constructing a smarter building

USA 843.534.1110
CAN 905.819.5000

www.asmmodularfloors.com
customerservice@asmmodularfloors.com



PART NAME:

**S-SERIES HOLLOW STEEL TILE
COVERED PANEL WITH ASM SMART
TRIM STANDARD OR METRIC**

PART NO:

SCALE:

NTS

DWG:

ASM_1005B.dwg

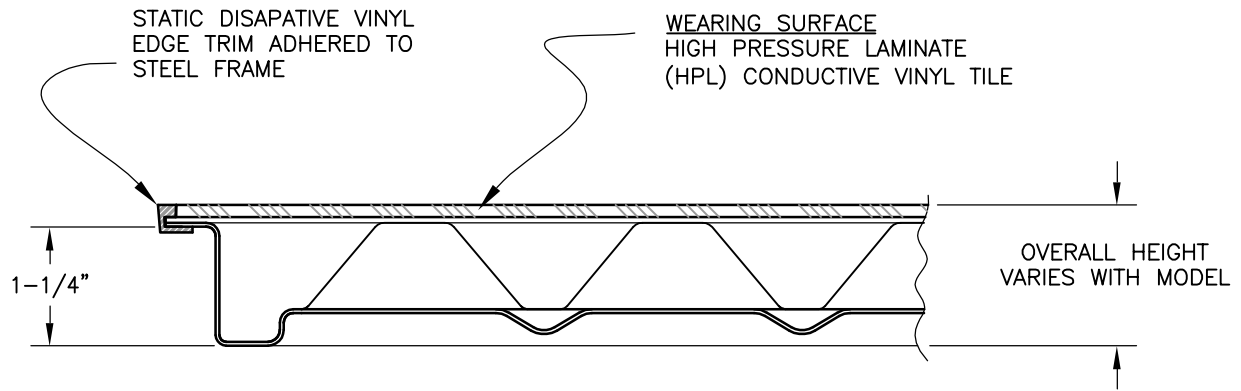

PARTIAL SECTION VIEW

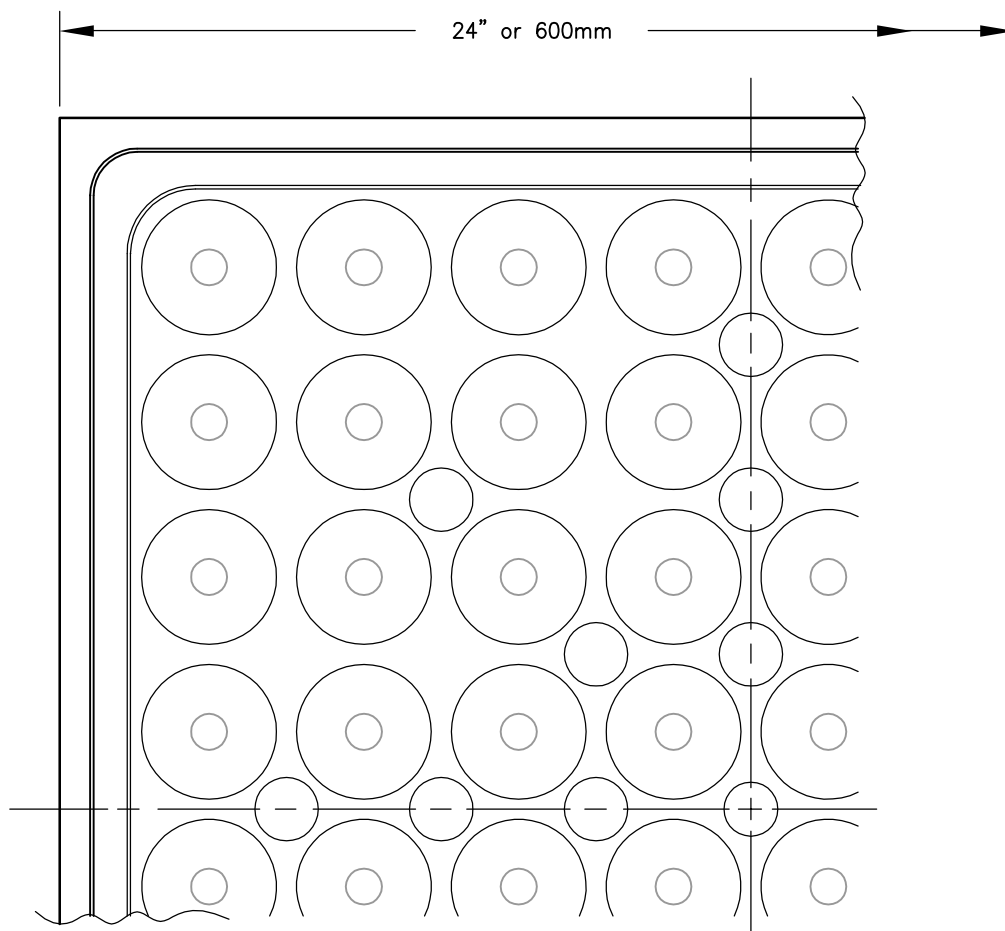

PARTIAL BOTTOM VIEW

SUPPLEMENTARY NOTES

1. PANEL IS PROTECTED WITH POWDER COAT EPOXY

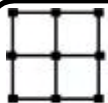

ASM

Constructing a smarter building

USA 843.534.1110
CAN 905.819.5000

www.asmmodularfloors.com
customerservice@asmmodularfloors.com

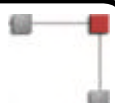

PART NAME:

**S-SERIES HOLLOW STEEL TILE
COVERED PANEL WITH EDGE TRIM
STANDARD OR METRIC**

PART NO:

SCALE:

NTS

DWG:

ASM_1005.dwg